

Bottom view

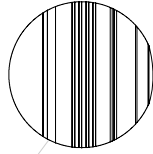

Detail view

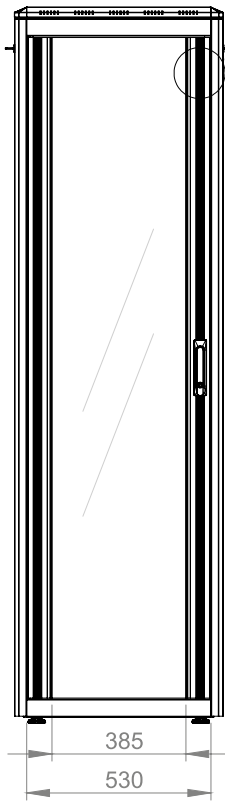

Front view

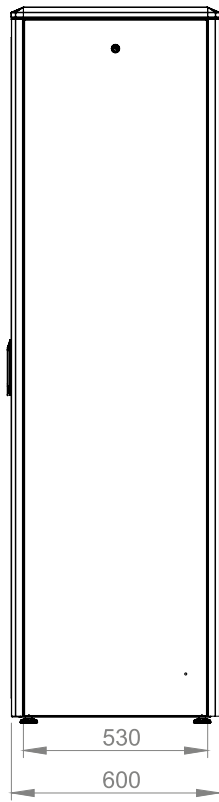

Side view

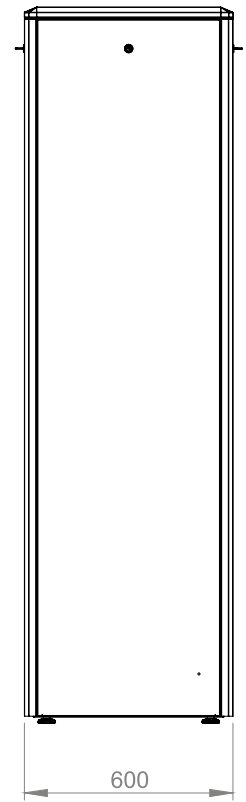

Rear view

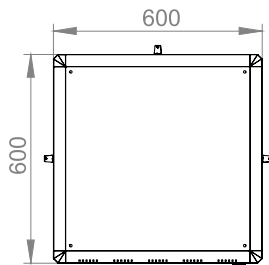

Top view

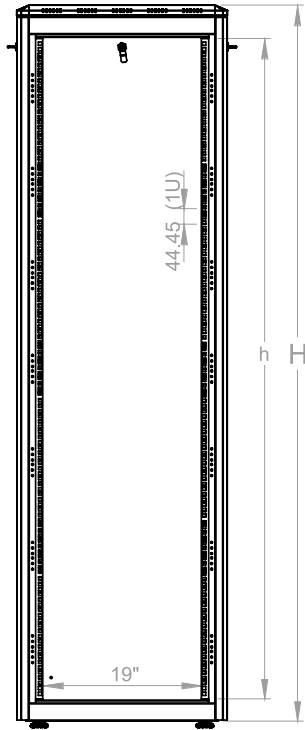

Dimensions in width and height

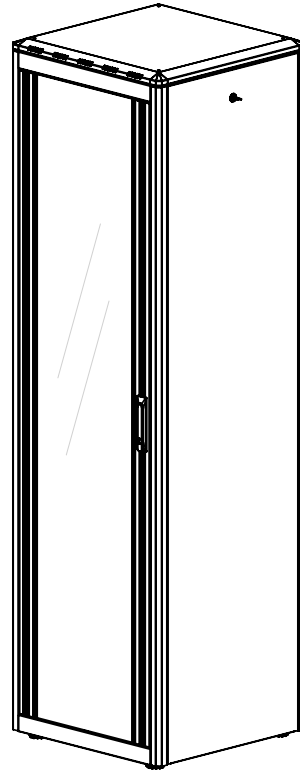

Isometric view

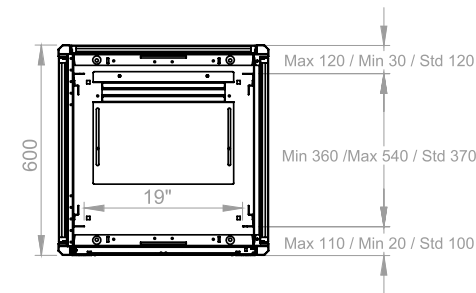
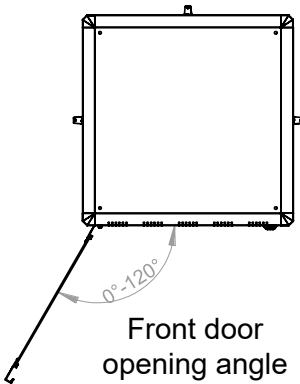

Max/std/min equipment mounting distance

| | h | H |
|------------|---------|---------|
| 12U | 533 mm | 720 mm |
| 16U | 711 mm | 898 mm |
| 20U | 889 mm | 1076 mm |
| 22U | 978 mm | 1164 mm |
| 26U | 1155 mm | 1342 mm |
| 32U | 1422 mm | 1609 mm |
| 36U | 1600 mm | 1787 mm |
| 39U | 1733 mm | 1920 mm |
| 42U | 1867 mm | 2053 mm |
| 45U | 2000 mm | 2187 mm |
| 47U | 2089 mm | 2276 mm |