

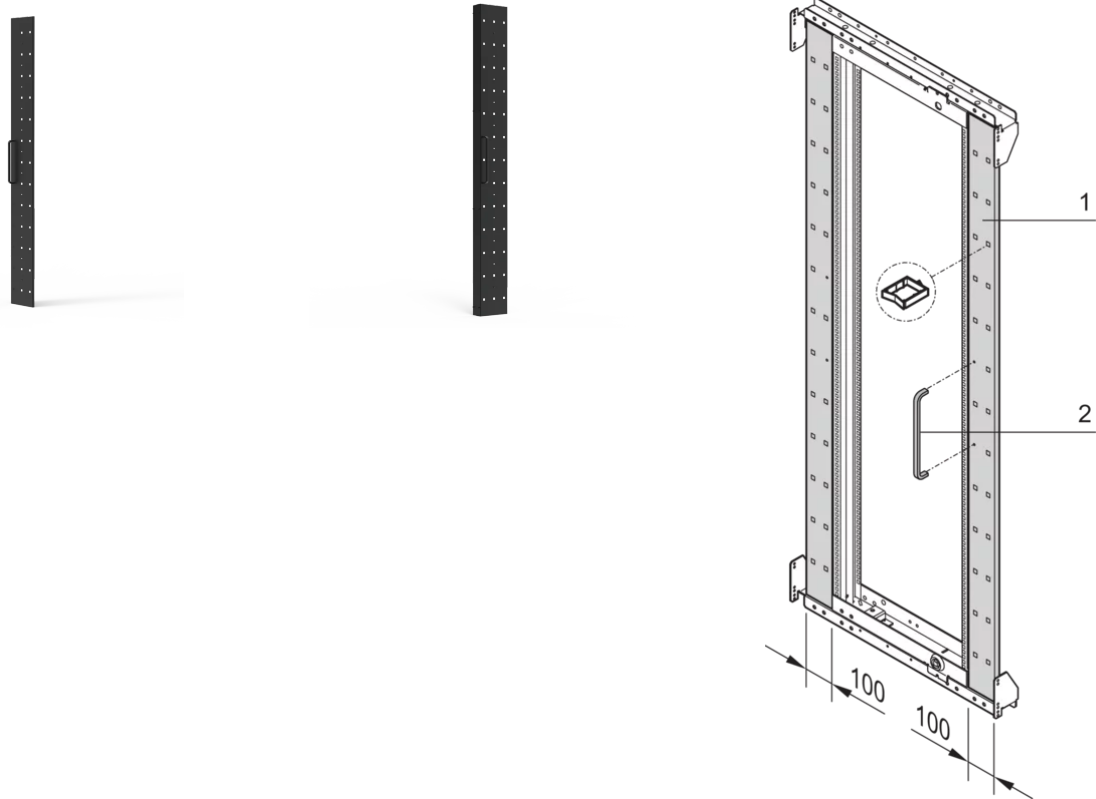

SCHROFF

21630-746 VARISTAR CP 19" SWING CABINET FRAME TRIM, 24 U ASYMMETRICAL ASSEMBLY



KEY FEATURES

Includes handle and cut-out for cable eyes

To cover the gap between swing frame and cabinet upright for 800 mm wide cabinets

Maximum swing bracket: 120 or 160

For swing frame with load-carrying capacity 150 kg, a stop is recommended for security reasons

Locking no. 333

Spare key for DIN semi-profile cylinder

PRODUCT ATTRIBUTES

Product Type: Cabinet/Rack Frame

Product Family: Varistar CP

Type: Swing

Material: Steel

Color: Black Grey

Color Code: RAL 7021

Rack Height: 24 U

Protection Rating: IP20

Works With: Varistar CP

ADDITIONAL PRODUCT DETAILS

Varistar CP swing frame provides optimum space usage inside the rack. The swing frames come with handles.

Varistar CP swing frame provides optimum space usage inside the rack. The swing frames come with handles.

Please purchase the grounding kit separately.

North America

All locations

+1.763.422.2661

Chat with us:

schroff.nvent.com

Europe

Straubenhardt, Germany

+49.7082.794.0

Betschdorf, France

+33.3.88.90.64.90

Warsaw, Poland

+48.22.209.98.35

Assago, Italy

+39.02.932.7141

Chat with us:

schroff.nvent.com

Asia

Shanghai, China

+86.21.2412.6943

Qingdao, China

+86.532.8771.6101

Singapore

+65.6768.5800

Shin-Yokohama, Japan

+81.45.476.0271

Chat with us:

schroff.nvent.com

Middle East & India

Dubai, United Arab Emirates

+971.4.378.1700

Bangalore, India

+91.80.6715.2001

Istanbul, Turkey

+90.216.250.7374

Chat with us:

schroff.nvent.com



Our powerful portfolio of brands:
nVent.com CADDY ERICO HOFFMAN RAYCHEM SCHROFF TRACER

© 2024 nVent. All nVent marks and logos are owned or licensed by nVent Services GmbH or its affiliates. All other trademarks are the property of their respective owners.

nVent reserves the right to change specifications without notice.