

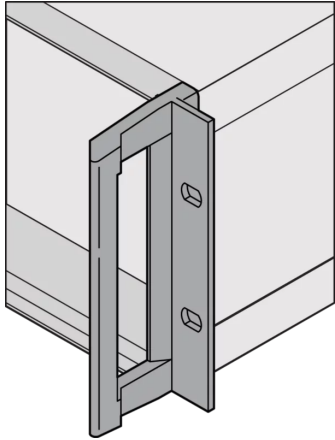

SCHROFF

24572-705 19" MOUNTING BRACKET WITH HANDLE FOR RETROFITTING, RATIOACPRO AIR, 3/4 U



KEY FEATURES

For conversion of cases with cover strip, front handle or 19" mounting bracket

PRODUCT ATTRIBUTES

Product Type: Handle

Type: Static

Works With: Cases

Handle Type: Front Handle with 19" Mounting Brackets

Material: Aluminum

Color: Dark Grey

Package Quantity: 2

ADDITIONAL PRODUCT DETAILS

With this 19" mounting bracket with handles the flexible and robust RatiopacPRO/-AIR case, is simple to convert from desktop to 19" rack-mountable.

No slide rails may be used when fitting into cabinets or 19" cases.



North America

All locations
+1.763.422.2661
Chat with us:
schroff.nvent.com

Europe

Straubenhardt, Germany
+49.7082.794.0
Betschdorf, France
+33.3.88.90.64.90
Warsaw, Poland
+48.22.209.98.35
Assago, Italy
+39.02.932.7141
Chat with us:
schroff.nvent.com

Asia

Shanghai, China
+86.21.2412.6943
Qingdao, China
+86.532.8771.6101
Singapore
+65.6768.5800
Shin-Yokohama, Japan
+81.45.476.0271
Chat with us:
schroff.nvent.com

Middle East & India

Dubai, United Arab Emirates
+971.4.378.1700
Bangalore, India
+91.80.6715.2001
Istanbul, Turkey
+90.216.250.7374
Chat with us:
schroff.nvent.com



Our powerful portfolio of brands:
nVent.com **CADDY ERICO HOFFMAN RAYCHEM SCHROFF TRACER**