

24568-020 EUROPACPRO COVER PLATE FOR BOLTING TO RUGGED SIDE PANEL,  
84 HP, 355 MM

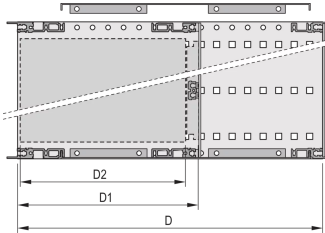
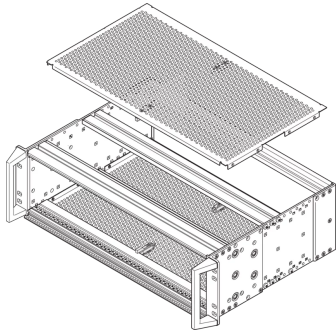

**KEY FEATURES**

Perforation degree 58%

**PRODUCT ATTRIBUTES**

Product Type: Cover Plate

Product Family: EuropacPRO

Type: Perforated

Rack Width: 84 HP

Depth: 355 mm

Package Quantity: 1

Package Unit: Pair

Torque: 2.1 N·m

**ADDITIONAL PRODUCT DETAILS**

A cover plate is used for electromagnetic shielding or as mechanical protection.

A top cover locking mechanism is optionally available that also fixes the top cover in the front and rear guide rail.

4 stainless steel EMC contact strips per subrack-are required for shielding, please order separately.



**North America**

All locations  
+1.763.422.2661  
Chat with us:  
[schroff.nvent.com](https://schroff.nvent.com)

**Europe**

Straubenhardt, Germany  
+49.7082.794.0  
Betschdorf, France  
+33.3.88.90.64.90  
Warsaw, Poland  
+48.22.209.98.35  
Assago, Italy  
+39.02.932.7141  
Chat with us:  
[schroff.nvent.com](https://schroff.nvent.com)

**Asia**

Shanghai, China  
+86.21.2412.6943  
Qingdao, China  
+86.532.8771.6101  
Singapore  
+65.6768.5800  
Shin-Yokohama, Japan  
+81.45.476.0271  
Chat with us:  
[schroff.nvent.com](https://schroff.nvent.com)

**Middle East & India**

Dubai, United Arab Emirates  
+971.4.378.1700  
Bangalore, India  
+91.80.6715.2001  
Istanbul, Turkey  
+90.216.250.7374  
Chat with us:  
[schroff.nvent.com](https://schroff.nvent.com)



Our powerful portfolio of brands:  
[nVent.com](https://nVent.com) **CADDY ERICO HOFFMAN RAYCHEM SCHROFF TRACER**