

27230-146 NOVASTAR MOBILE PLINTH, 553W 500D

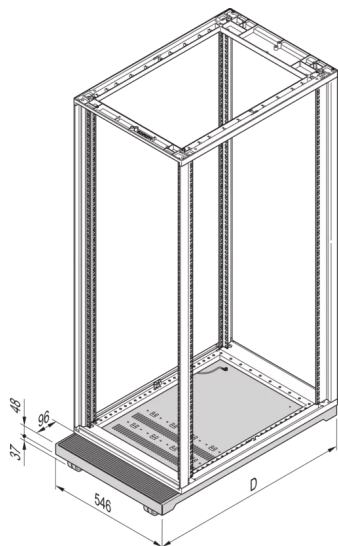

**KEY FEATURES**

St, 2 mm

4 castors

Rubber mat, 3 mm

Load-carrying capacity 200 kg

Base/plinth height H = 100 mm

**PRODUCT ATTRIBUTES**

Product Type: Cabinet/Rack Base

Product Family: Novastar

Type: Base Plinth

Color: Black Grey

Color Code: RAL 7021

Width: 553 mm

Depth: 500 mm

## ADDITIONAL PRODUCT DETAILS

---

Aluminum mobile base plinth with load capacity of 200 kg, for aluminum cabinets with 600 mm breadth.

## CERTIFICATIONS

---



### North America

All locations  
+1.763.422.2661  
Chat with us:  
[schroff.nvent.com](https://schroff.nvent.com)

### Europe

Straubenhardt, Germany  
+49.7082.794.0  
Betschdorf, France  
+33.3.88.90.64.90  
Warsaw, Poland  
+48.22.209.98.35  
Assago, Italy  
+39.02.932.7141  
Chat with us:  
[schroff.nvent.com](https://schroff.nvent.com)

### Asia

Shanghai, China  
+86.21.2412.6943  
Qingdao, China  
+86.532.8771.6101  
Singapore  
+65.6768.5800  
Shin-Yokohama, Japan  
+81.45.476.0271  
Chat with us:  
[schroff.nvent.com](https://schroff.nvent.com)

### Middle East & India

Dubai, United Arab Emirates  
+971.4.378.1700  
Bangalore, India  
+91.80.6715.2001  
Istanbul, Turkey  
+90.216.250.7374  
Chat with us:  
[schroff.nvent.com](https://schroff.nvent.com)



Our powerful portfolio of brands:  
[nVent.com](https://nVent.com) **CADDY ERICO HOFFMAN RAYCHEM SCHROFF TRACER**

© 2023 nVent. All nVent marks and logos are owned or licensed by nVent Services GmbH or its affiliates. All other trademarks are the property of their respective owners.

nVent reserves the right to change specifications without notice.