

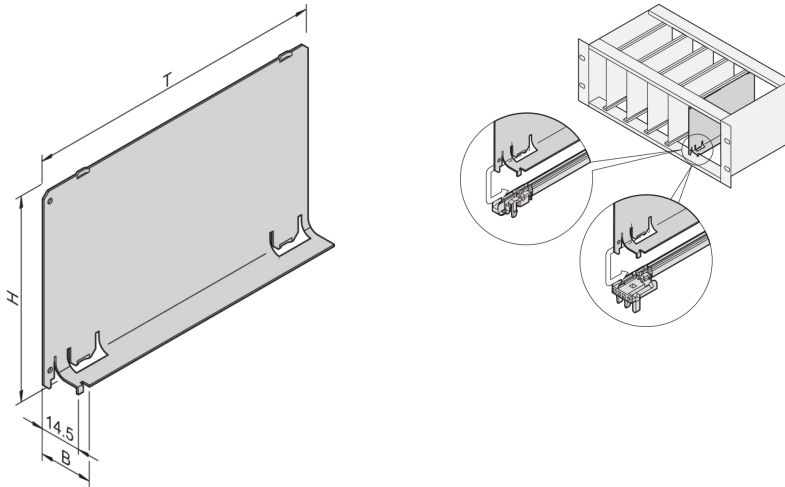

SCHROFF

## 34562-826 AIR BAFFLE WITHOUT FRONT PANEL, 6 U, 4 HP, DEPTH 160 MM



### KEY FEATURES

Air baffles eliminate air leaks from empty slots

Cover is pushed into the guide rail

### PRODUCT ATTRIBUTES

Product Type: Air Baffle

Product Family: EuropacPRO; RatiopacPRO; RatiopacPRO AIR; CompacPRO; PropacPRO; Inpac

Type: Without Front Panel

Works With: Subracks; Cases

Rack Height: 6 U

Rack Width: 4 HP

Depth: 160 mm

Material: Aluminum

Package Quantity: 1

## ADDITIONAL PRODUCT DETAILS

---

The air baffle without a partial front panel can be combined with a front panel that covers the complete width. It covers an empty slot to eliminate an air leak.

Air baffle for 280-mm deep and for 80-mm rear I/O boards available on request.

## CERTIFICATIONS

---



### North America

All locations  
+1.763.422.2661  
Chat with us:  
[schroff.nvent.com](https://schroff.nvent.com)

### Europe

Straubenhardt, Germany  
+49.7082.794.0  
Betschdorf, France  
+33.3.88.90.64.90  
Warsaw, Poland  
+48.22.209.98.35  
Assago, Italy  
+39.02.932.7141  
Chat with us:  
[schroff.nvent.com](https://schroff.nvent.com)

### Asia

Shanghai, China  
+86.21.2412.6943  
Qingdao, China  
+86.532.8771.6101  
Singapore  
+65.6768.5800  
Shin-Yokohama, Japan  
+81.45.476.0271  
Chat with us:  
[schroff.nvent.com](https://schroff.nvent.com)

### Middle East & India

Dubai, United Arab Emirates  
+971.4.378.1700  
Bangalore, India  
+91.80.6715.2001  
Istanbul, Turkey  
+90.216.250.7374  
Chat with us:  
[schroff.nvent.com](https://schroff.nvent.com)



Our powerful portfolio of brands:  
[nVent.com](https://nVent.com) **CADDY ERICO HOFFMAN RAYCHEM SCHROFF TRACER**

© 2023 nVent. All nVent marks and logos are owned or licensed by nVent Services GmbH or its affiliates. All other trademarks are the property of their respective owners.

nVent reserves the right to change specifications without notice.