

24572-064 RATIOACPRO, COMPLETE CASE, DESKTOP, SHIELDED, FRONT TRIM, 6 U, 42 HP, 315 MM

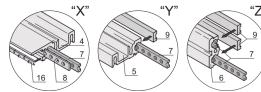
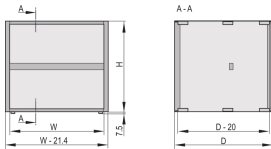
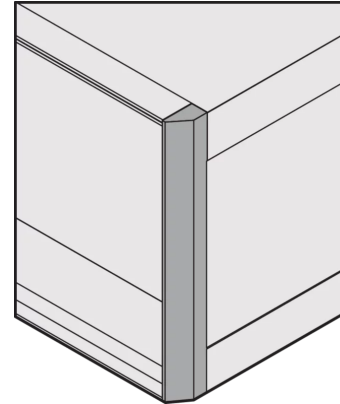
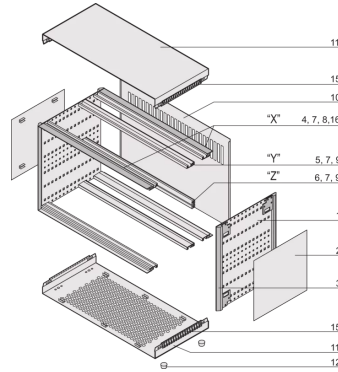

**KEY FEATURES**

Desktop enclosure with pre-configured components, in accordance to IEC 60297-3-101; prepared for 19" components, e.g. plug-in units and euroboards

Shielded

Version with cover strips

Ventilation slit in base plate

Rear panel perforated

Conforms with DIN EN 62368-1

**PRODUCT ATTRIBUTES**

Product Type: Case

Product Family: RatiopacPRO

Type: Case for 19" Components

Rack Height: 6 U

Height: 265.9 mm

Usable Height: 245.7 mm

Rack Width: 42 HP

Width: 235.5 mm

Usable Width: 219 mm

Depth: 315.5 mm

EMC Shielding: Yes

Static Load: 25 kg

Protection Rating: IP20

Front Frame Construction: Side Trim; Horizontal Rails

Cooling Option: No

Complies With: IEC 60297-3-101; IEC 60297-3-102; IEEE 1101.1; IEEE 1101.10; IEEE 1101.11

Package Quantity: 1

## ADDITIONAL PRODUCT DETAILS

---

The nVent SCHROFF RatiopacPRO case with EMC shielding, provides electronics protection for 19" and individual electronic assemblies. This flexible and robust case is simple to convert from desktop to a 19" rack mount case and includes four different style options. This version of the case provides a sleek design for desktop applications.

Modifications (special colours or sizes).

Custom solutions (cut-outs in top cover, base plate or side panels).

Assembly service from 1 piece.

## CERTIFICATIONS

---



### North America

All locations

+1.763.422.2661

Chat with us:

[schroff.nvent.com](https://schroff.nvent.com)

### Europe

Straubenhardt, Germany

+49.7082.794.0

Betschdorf, France

+33.3.88.90.64.90

Warsaw, Poland

+48.22.209.98.35

Assago, Italy

+39.02.932.7141

Chat with us:

[schroff.nvent.com](https://schroff.nvent.com)

### Asia

Shanghai, China

+86.21.2412.6943

Qingdao, China

+86.532.8771.6101

Singapore

+65.6768.5800

Shin-Yokohama, Japan

+81.45.476.0271

Chat with us:

[schroff.nvent.com](https://schroff.nvent.com)

### Middle East & India

Dubai, United Arab Emirates

+971.4.378.1700

Bangalore, India

+91.80.6715.2001

Istanbul, Turkey

+90.216.250.7374

Chat with us:

[schroff.nvent.com](https://schroff.nvent.com)



Our powerful portfolio of brands:  
[nVent.com](https://nVent.com) **CADDY ERICO HOFFMAN RAYCHEM SCHROFF TRACER**

© 2023 nVent. All nVent marks and logos are owned or licensed by nVent Services GmbH or its affiliates. All other trademarks are the property of their respective owners.

nVent reserves the right to change specifications without notice.