

24571-092 RATIOACPRO, DESKTOP CASE, RETROFITTABLE SHIELDING, FRONT TRIM, 4 U, 84 HP, 495 MM

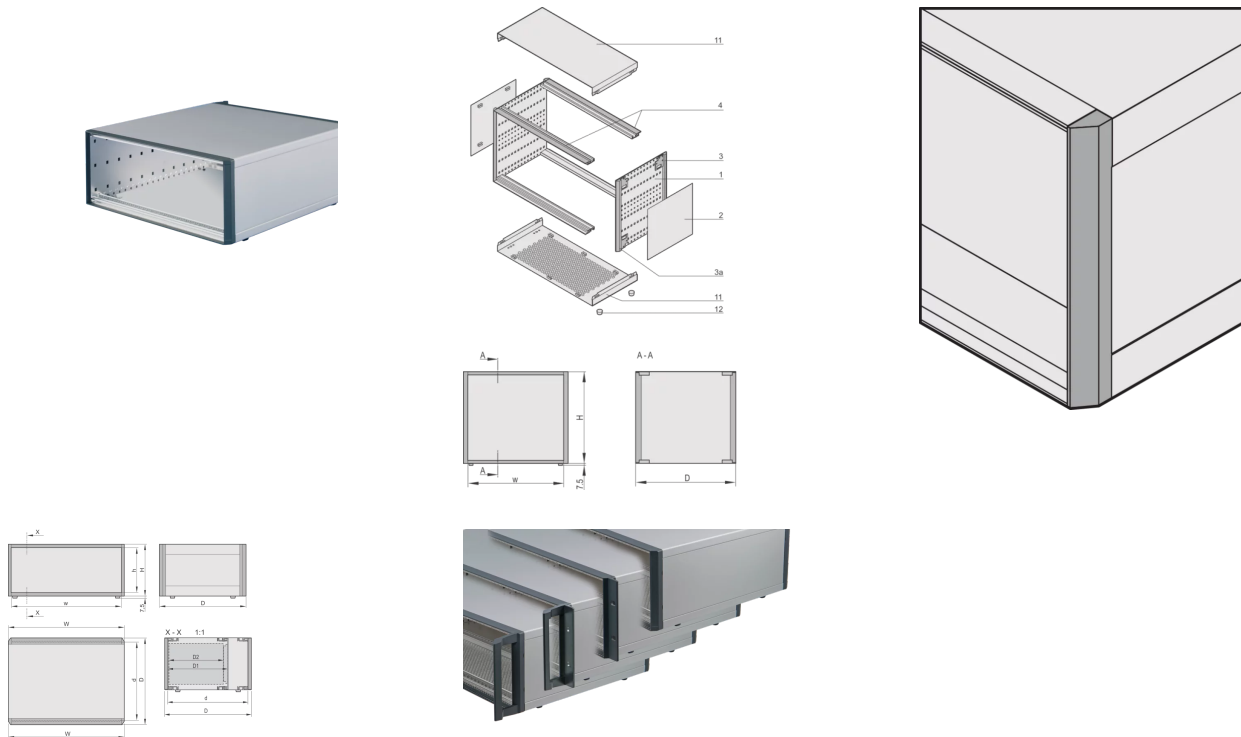

KEY FEATURES

Designed for insertion/extractor handles in accordance with IEC 60297-3-102 and IEEE-1101.10 for CompactPCI and VME64x applications

Cases for individual assembly with 19" standard components or specific internal mounting, e.g. with mounting plate

Retrofittable EMC shielding

Version with cover strips

For board depth 160 mm, 220 mm, 280 mm, and 340 mm (depending on case depth)

Symmetrical design, identical front and rear side

No visible screws; cladding parts removable without tools

Conforms with DIN EN 62368-1

PRODUCT ATTRIBUTES

Product Type: Case

Product Family: RatiopacPRO

Type: Case for Individual Electronic Components

Rack Height: 4 U

Height: 177 mm

Usable Height: 156.8 mm

Rack Width: 84 HP

Width: 448.9 mm

Usable Width: 432 mm

Depth: 495.5 mm

EMC Shielding: No (Retrofittable)

Static Load: 25 kg

Protection Rating: IP20

Front Frame Construction: Side Trim; Horizontal Rails

Cooling Option: No

Complies With: IEC 60297-3-101; IEC 60297-3-102; IEEE 1101.1; IEEE 1101.10; IEEE 1101.11

Package Quantity: 1

ADDITIONAL PRODUCT DETAILS

The nVent SCHROFF RatiopacPRO case provides electronics protection for 19" and individual electronic assemblies. This flexible and robust case is simple to convert from desktop to a 19" rack mount case and includes four different style options. This version of the case provides a sleek design for desktop applications.

Modifications (special colours or sizes).

Custom solutions (cut-outs in top cover, base plate or side panels).

Assembly service from 1 piece.

CERTIFICATIONS

The logo features the word "ROHS" in a large, bold, black font with a green checkmark above the letter "O". Below it, the word "COMPLIANT" is written in a smaller, green, sans-serif font.

The logo consists of the letters "DIN" in a large, bold, blue, sans-serif font, enclosed within a blue rectangular border.

North America

All locations

+1.763.422.2661

Chat with us:

schroff.nvent.com

Europe

Straubenhardt, Germany

+49.7082.794.0

Betschdorf, France

+33.3.88.90.64.90

Warsaw, Poland

+48.22.209.98.35

Assago, Italy

+39.02.932.7141

Chat with us:

schroff.nvent.com

Asia

Shanghai, China

+86.21.2412.6943

Qingdao, China

+86.532.8771.6101

Singapore

+65.6768.5800

Shin-Yokohama, Japan

+81.45.476.0271

Chat with us:

schroff.nvent.com

Middle East & India

Dubai, United Arab Emirates

+971.4.378.1700

Bangalore, India

+91.80.6715.2001

Istanbul, Turkey

+90.216.250.7374

Chat with us:

schroff.nvent.com



Our powerful portfolio of brands:
nVent.com **CADDY ERICO HOFFMAN RAYCHEM SCHROFF TRACER**

© 2023 nVent. All nVent marks and logos are owned or licensed by nVent Services GmbH or its affiliates. All other trademarks are the property of their respective owners.

nVent reserves the right to change specifications without notice.