

21500-037 EUROPACPRO COVER PLATE FOR BOLTING TO SIDE PANEL, SNCF, 84 HP, 235-MM

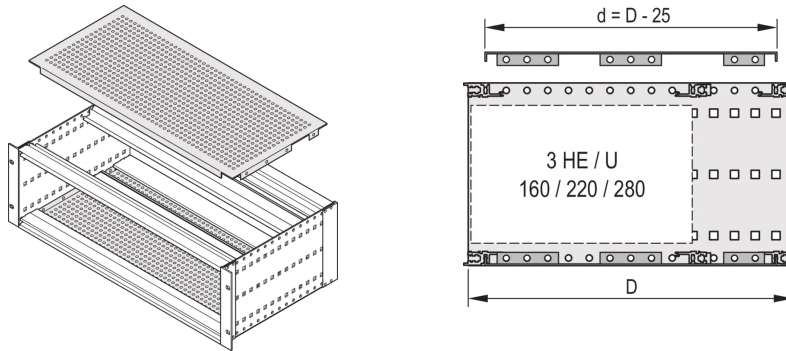

KEY FEATURES

For variable positioning of horizontal rails e.g. for PCBs with standard formats

Perforation degree 58-%

Suitable for use with all horizontal rails

PRODUCT ATTRIBUTES

Product Type: Cover Plate

Product Family: EuropacPRO

Type: Perforated

Rack Width: 84 HP

Depth: 235 mm

Package Quantity: 1

Package Unit: Pair

Torque: 2.1 N·m

ADDITIONAL PRODUCT DETAILS

A cover plate is used for electromagnetic shielding or as mechanical protection. The cover can be screwed onto the side panel. Can be used for railway subtracks in accordance with SNCF.



North America

All locations
+1.763.422.2661
Chat with us:
schroff.nvent.com

Europe

Straubenhardt, Germany
+49.7082.794.0
Betschdorf, France
+33.3.88.90.64.90
Warsaw, Poland
+48.22.209.98.35
Assago, Italy
+39.02.932.7141
Chat with us:
schroff.nvent.com

Asia

Shanghai, China
+86.21.2412.6943
Qingdao, China
+86.532.8771.6101
Singapore
+65.6768.5800
Shin-Yokohama, Japan
+81.45.476.0271
Chat with us:
schroff.nvent.com

Middle East & India

Dubai, United Arab Emirates
+971.4.378.1700
Bangalore, India
+91.80.6715.2001
Istanbul, Turkey
+90.216.250.7374
Chat with us:
schroff.nvent.com



Our powerful portfolio of brands:
nVent.com **CADDY ERICO HOFFMAN RAYCHEM SCHROFF TRACER**