

21130-344 VARISTAR 19" SHELF, TELESCOPIC, 30 KG, RAL 7021, SHORTENED, 600W 700D

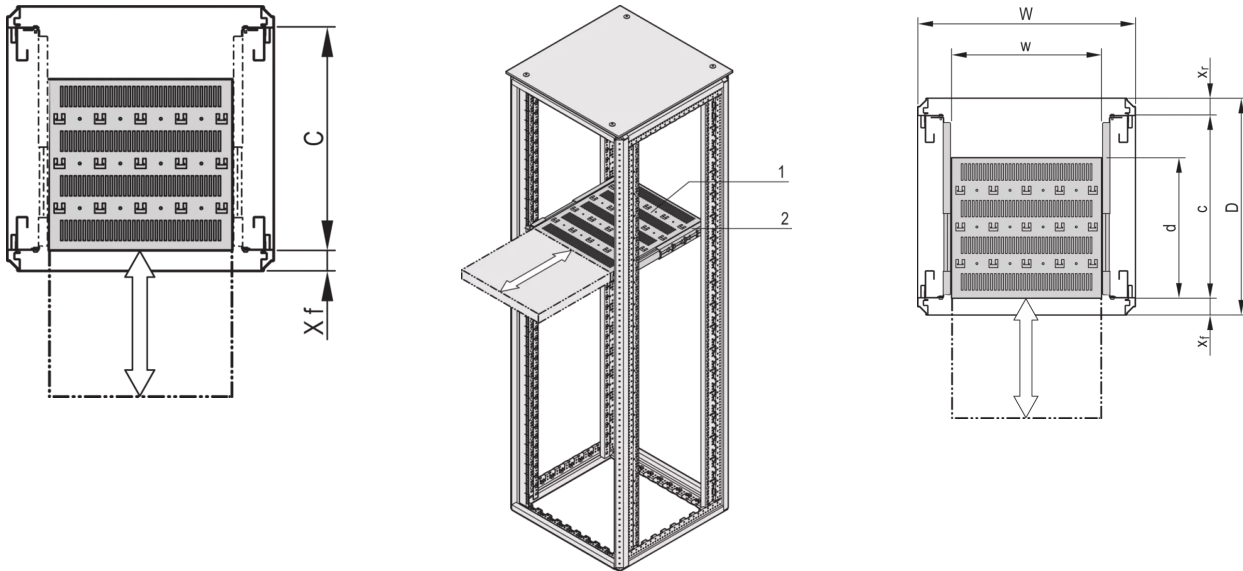

KEY FEATURES

- Static load-carrying capacity at full extension 30-kg
- Perforated for assembling cable ties
- Mounting height 1 U, for mounting on four 19" panel/slide mounts
- Incl. telescopic slides
- Hammer head perforation to fix cable ties

PRODUCT ATTRIBUTES

- Product Type: Shelf
- Product Family: Varistar
- Type: Telescopic Shelf, Reduced Depth
- Color: Black Grey
- Color Code: RAL 7021
- Width: 417 mm
- Depth: 700 mm

ADDITIONAL PRODUCT DETAILS

Varistar 19" Shelf, Stationary with 30 KG load capacity, perforated for ease of assembly.

Mounting bracket for assembly of the telescopic slide on the frame please order separately.

CERTIFICATIONS



North America

All locations
+1.763.422.2661
Chat with us:
schroff.nvent.com

Europe

Straubenhardt, Germany
+49.7082.794.0
Betschdorf, France
+33.3.88.90.64.90
Warsaw, Poland
+48.22.209.98.35
Assago, Italy
+39.02.932.7141
Chat with us:
schroff.nvent.com

Asia

Shanghai, China
+86.21.2412.6943
Qingdao, China
+86.532.8771.6101
Singapore
+65.6768.5800
Shin-Yokohama, Japan
+81.45.476.0271
Chat with us:
schroff.nvent.com

Middle East & India

Dubai, United Arab Emirates
+971.4.378.1700
Bangalore, India
+91.80.6715.2001
Istanbul, Turkey
+90.216.250.7374
Chat with us:
schroff.nvent.com



Our powerful portfolio of brands:
nVent.com **CADDY ERICO HOFFMAN RAYCHEM SCHROFF TRACER**

© 2023 nVent. All nVent marks and logos are owned or licensed by nVent Services GmbH or its affiliates. All other trademarks are the property of their respective owners.

nVent reserves the right to change specifications without notice.