

21130-295 VARISTAR EMC BASE PLATE FOR REAR CABLE DUCTING, PLAIN, 600W 900D

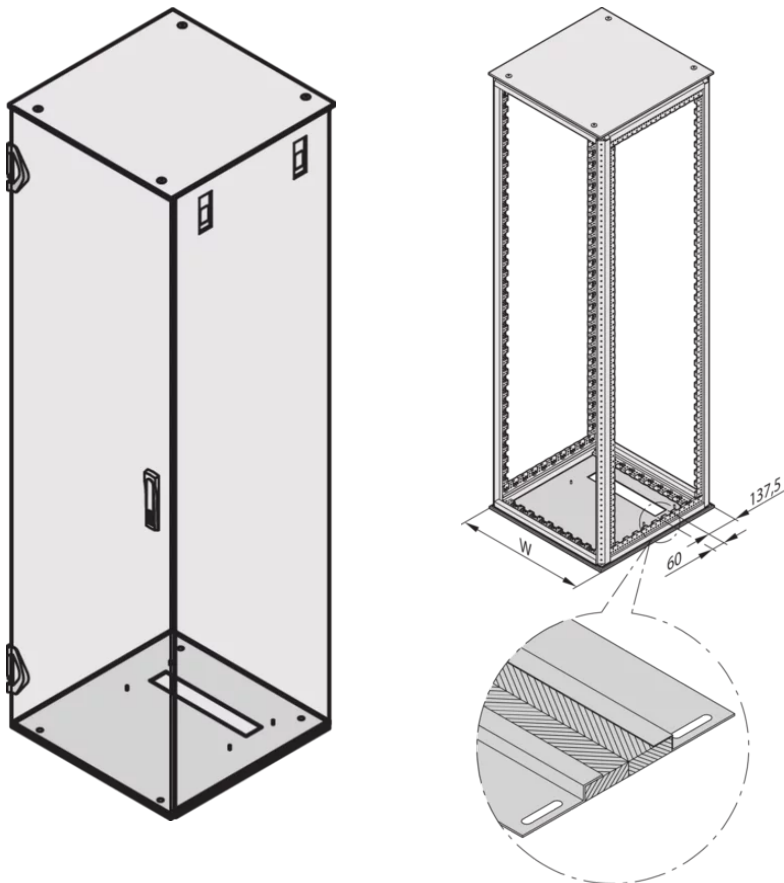

KEY FEATURES

Incl. GND/grounding

Installation from outside

Cutout at rear

60 mm deep

AlZn, 1.5 mm

Cable ducting with EMC gasket

PRODUCT ATTRIBUTES

Product Type: Cabinet/Rack Base

Product Family: Varistar

Type: Base Plate, EMC

Finish: Aluminum-Zinc Plated

Width: 600 mm

Depth: 900 mm

ADDITIONAL PRODUCT DETAILS

Varistar Base Plate for Rear Cable Ducting, plain for EMC.

Assembled from the bottom.

CERTIFICATIONS



North America

All locations

+1.763.422.2661

Chat with us:

schroff.nvent.com

Europe

Straubenhardt, Germany

+49.7082.794.0

Betschdorf, France

+33.3.88.90.64.90

Warsaw, Poland

+48.22.209.98.35

Assago, Italy

+39.02.932.7141

Chat with us:

schroff.nvent.com

Asia

Shanghai, China

+86.21.2412.6943

Qingdao, China

+86.532.8771.6101

Singapore

+65.6768.5800

Shin-Yokohama, Japan

+81.45.476.0271

Chat with us:

schroff.nvent.com

Middle East & India

Dubai, United Arab Emirates

+971.4.378.1700

Bangalore, India

+91.80.6715.2001

Istanbul, Turkey

+90.216.250.7374

Chat with us:

schroff.nvent.com



Our powerful portfolio of brands:
nVent.com **CADDY ERICO HOFFMAN RAYCHEM SCHROFF TRACER**

© 2023 nVent. All nVent marks and logos are owned or licensed by nVent Services GmbH or its affiliates. All other trademarks are the property of their respective owners.

nVent reserves the right to change specifications without notice.