

21101-222 PANHEAD SCREW, POZIDRIVE, CROSS RECESS M2.5X16, STEEL NICKEL PLATED

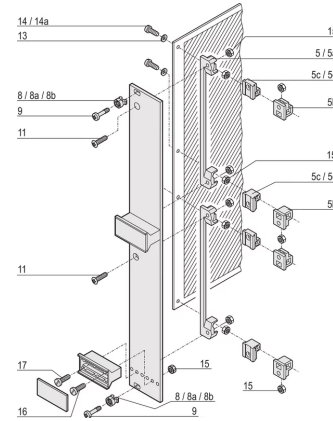
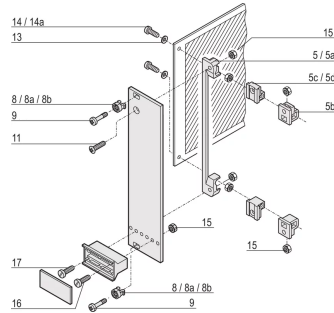
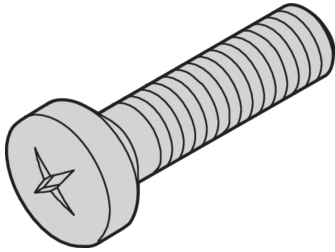

KEY FEATURES

Panhead screw, pozidrive

PRODUCT ATTRIBUTES

Product Type: Screw

Type: Panhead Screw

Works With: Backplanes; Test Adapters

Package Quantity: 100

Thread Size: M2.5

Length: 16 mm

Material: Steel

Finish: Nickel Plated

ADDITIONAL PRODUCT DETAILS

Panhead Screw, Pozidrive.



North America

All locations
+1.763.422.2661
Chat with us:
schroff.nvent.com

Europe

Straubenhardt, Germany
+49.7082.794.0
Betschdorf, France
+33.3.88.90.64.90
Warsaw, Poland
+48.22.209.98.35
Assago, Italy
+39.02.932.7141
Chat with us:
schroff.nvent.com

Asia

Shanghai, China
+86.21.2412.6943
Qingdao, China
+86.532.8771.6101
Singapore
+65.6768.5800
Shin-Yokohama, Japan
+81.45.476.0271
Chat with us:
schroff.nvent.com

Middle East & India

Dubai, United Arab Emirates
+971.4.378.1700
Bangalore, India
+91.80.6715.2001
Istanbul, Turkey
+90.216.250.7374
Chat with us:
schroff.nvent.com



Our powerful portfolio of brands:
nVent.com **CADDY ERICO HOFFMAN RAYCHEM SCHROFF TRACER**