

20848-721 AIR BAFFLE, FRONT PANEL, REFROFIT SHIELDING, STEEL, 6 U, 4 HP, 220 MM

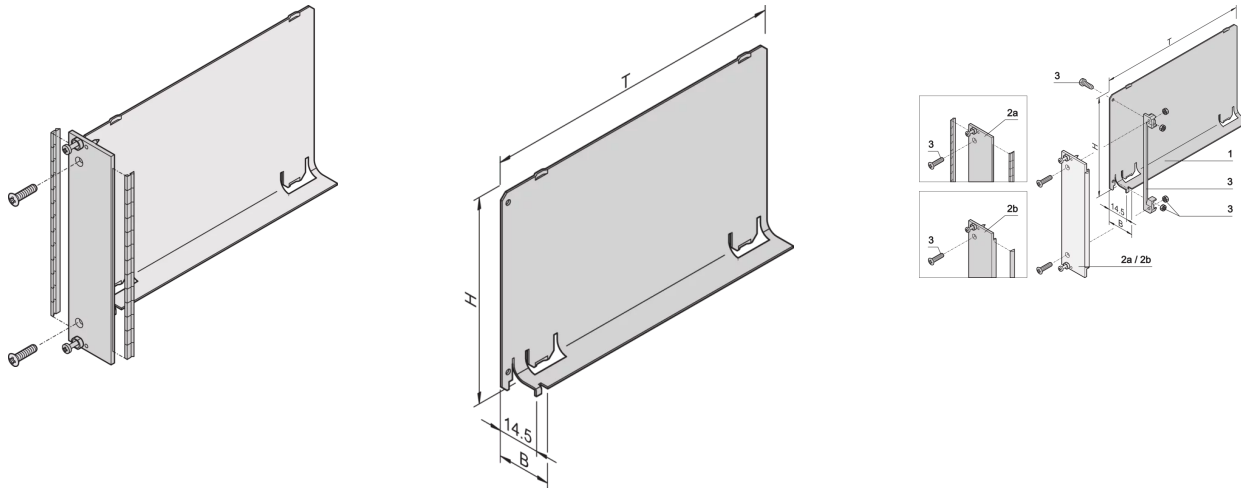

KEY FEATURES

Air baffle eliminates air leaks from empty slots

Cover is pushed into the guide rail

PRODUCT ATTRIBUTES

Product Type: Air Baffle

Product Family: EuropacPRO; RatiopacPRO; RatiopacPRO AIR; CompacPRO; PropacPRO; Inpac

Type: With Front Panel

Works With: Subracks; Cases

Rack Height: 6 U

Rack Width: 4 HP

Depth: 220 mm

EMC Shielding: No (Retrofittable)

Material: Aluminum

ADDITIONAL PRODUCT DETAILS

The air baffle with flat front panel covers an empty slot and eliminates an air leak. The flat front panel accepts a stainless steel EMC gasket.

Air baffle for 280-mm deep and for 80-mm rear I/O boards available on request.

CERTIFICATIONS



North America

All locations
+1.763.422.2661
Chat with us:
schroff.nvent.com

Europe

Straubenhardt, Germany
+49.7082.794.0
Betschdorf, France
+33.3.88.90.64.90
Warsaw, Poland
+48.22.209.98.35
Assago, Italy
+39.02.932.7141
Chat with us:
schroff.nvent.com

Asia

Shanghai, China
+86.21.2412.6943
Qingdao, China
+86.532.8771.6101
Singapore
+65.6768.5800
Shin-Yokohama, Japan
+81.45.476.0271
Chat with us:
schroff.nvent.com

Middle East & India

Dubai, United Arab Emirates
+971.4.378.1700
Bangalore, India
+91.80.6715.2001
Istanbul, Turkey
+90.216.250.7374
Chat with us:
schroff.nvent.com



Our powerful portfolio of brands:
nVent.com **CADDY ERICO HOFFMAN RAYCHEM SCHROFF TRACER**

© 2023 nVent. All nVent marks and logos are owned or licensed by nVent Services GmbH or its affiliates. All other trademarks are the property of their respective owners.

nVent reserves the right to change specifications without notice.