

20848-490 PLUG-IN UNIT KIT WITH EXTRACTION HANDLE TYPE 1, SHIELDED, GREY, 3 U, 10 HP

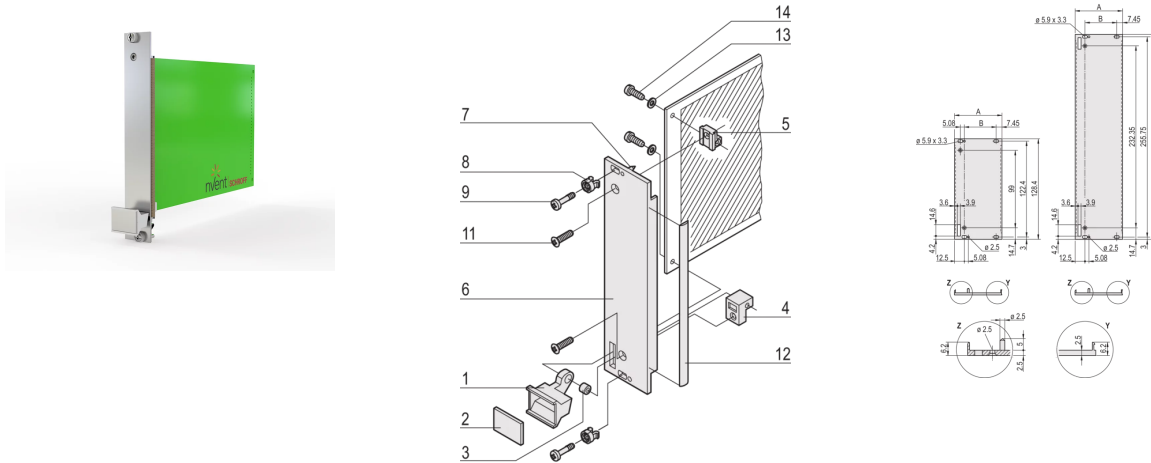

KEY FEATURES

Front panel, U-profile, shielded

Handle with extraction function

PRODUCT ATTRIBUTES

Product Type: Front Panel

Type: Front Panel with Handle (PIU)

Handle Type: Trapezoid, Type 1

Mounting: Screw-on Front

EMC Shielding: Yes

EMC Gasket Type: Textile

Material: Aluminum

Front Finish: Anodized

Rear Finish: Etched

Treated Edges: No

Rack Height: 3 U

Height: 128.4 mm

Rack Width: 10 HP

Width: 50.5 mm

Complies With: EN 45545-2, R22-R24, HL3; IEC 60297-3-101; IEEE 1101.1/11

Flammability Rating: UL® 94V-0

Package Quantity: 1

ADDITIONAL PRODUCT DETAILS

Plug-in unit, with extraction handle type 1 and U-shaped front panel. The grey handle is assembled on the front panel. The U-shaped panel enables the assembly of a textile gasket.

CERTIFICATIONS



North America

All locations
+1.763.422.2661
Chat with us:
schroff.nvent.com

Europe

Straubenhardt, Germany
+49.7082.794.0
Betschdorf, France
+33.3.88.90.64.90
Warsaw, Poland
+48.22.209.98.35
Assago, Italy
+39.02.932.7141
Chat with us:
schroff.nvent.com

Asia

Shanghai, China
+86.21.2412.6943
Qingdao, China
+86.532.8771.6101
Singapore
+65.6768.5800
Shin-Yokohama, Japan
+81.45.476.0271
Chat with us:
schroff.nvent.com

Middle East & India

Dubai, United Arab Emirates
+971.4.378.1700
Bangalore, India
+91.80.6715.2001
Istanbul, Turkey
+90.216.250.7374
Chat with us:
schroff.nvent.com



Our powerful portfolio of brands:
nVent.com **CADDY ERICO HOFFMAN RAYCHEM SCHROFF TRACER**

© 2023 nVent. All nVent marks and logos are owned or licensed by nVent Services GmbH or its affiliates. All other trademarks are the property of their respective owners.

nVent reserves the right to change specifications without notice.