

20110-192 TELESCOPIC SLIDE, UNIVERSAL, HEAVY LOAD, 2 U 400L

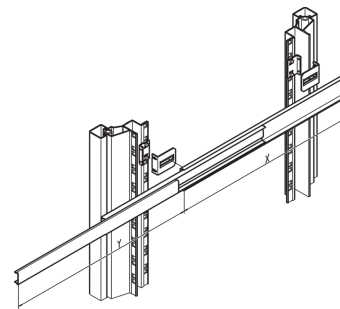
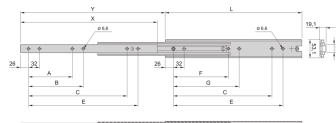
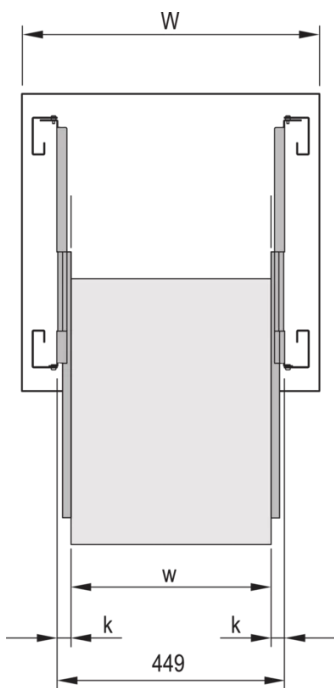
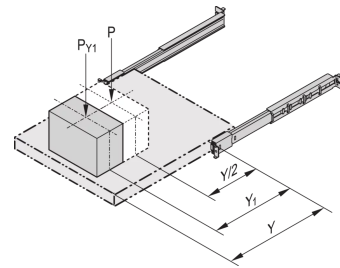

KEY FEATURES

Static load-carrying capacity per pair 72 - 100 kg

Lateral mounting on the 19" uprights (19" plane remains free for fixing the extension/drawer)

End stop damped

Extension length > 100 %

Rail width $k = 19.1$ mm, max. installation width of extension/drawer $w = 411$ mm

PRODUCT ATTRIBUTES

Product Type: Telescopic Slide

Type: Universal

Length: 400 mm

Static Load: 88 kg

ADDITIONAL PRODUCT DETAILS

Telescopic slides with 10 to 100 kg load capacity, > 100% extension length and with lateral mounting capability on 19". Robust telescopic sliding-rails - suitable for the installation of 19 inch chassis are suitable for mounting server enclosures from our product portfolio. Due to the extremely robust construction and high load capacity, the telescopic slides can also be used with very heavy housings.

To mount on 19" plane please order assembly kit separately.

Universal telescopic rails can also be fitted without additional components in non-standard applications, thus also in other than 19" cabinets.

CERTIFICATIONS



North America

All locations
+1.763.422.2661
Chat with us:
schroff.nvent.com

Europe

Straubenhardt, Germany
+49.7082.794.0
Betschdorf, France
+33.3.88.90.64.90
Warsaw, Poland
+48.22.209.98.35
Assago, Italy
+39.02.932.7141
Chat with us:
schroff.nvent.com

Asia

Shanghai, China
+86.21.2412.6943
Qingdao, China
+86.532.8771.6101
Singapore
+65.6768.5800
Shin-Yokohama, Japan
+81.45.476.0271
Chat with us:
schroff.nvent.com

Middle East & India

Dubai, United Arab Emirates
+971.4.378.1700
Bangalore, India
+91.80.6715.2001
Istanbul, Turkey
+90.216.250.7374
Chat with us:
schroff.nvent.com



Our powerful portfolio of brands:
nVent.com **CADDY ERICO HOFFMAN RAYCHEM SCHROFF TRACER**

© 2023 nVent. All nVent marks and logos are owned or licensed by nVent Services GmbH or its affiliates. All other trademarks are the property of their respective owners.

nVent reserves the right to change specifications without notice.