

16230-018 NOVASTAR CABINET WITHOUT DOOR AND REAR PANEL, HEAVY-DUTY, RAL 7021/7035, 2145H 553W 800D

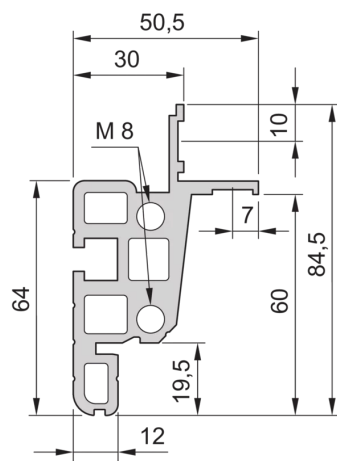
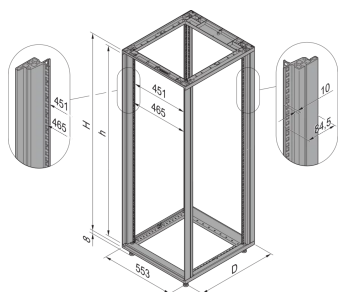
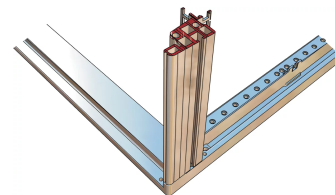
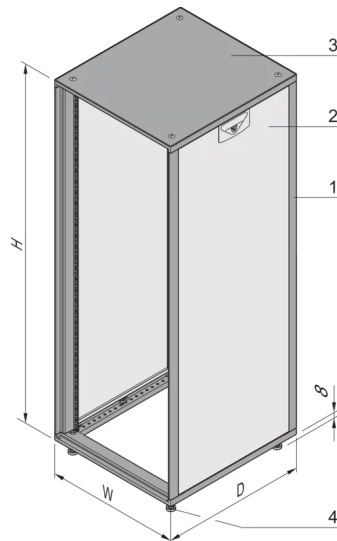

KEY FEATURES

Static load-carrying capacity up to 400 kg (see specification table)

Type of protection IP 20

Cabinet width only 553 mm

Flush cladding parts

All uprights (front and rear) with 19" cut-outs

Colors: RAL 7021 or color combination RAL 7021/ RAL 7035

Bolted, die-cast frame with Al extrusions

Without door and rear panel

PRODUCT ATTRIBUTES

Product Type: Cabinet

Product Family: Novastar

Frame Material: Aluminum

Frame Color: Black Grey

Frame Color Code: RAL 7021

Cladding Material: Steel

Cladding Color: Light Grey

Cladding Color Code: RAL 7035

Rack Height: 47 U

Height: 2145 mm

Width: 553 mm

Depth: 800 mm

Static Load: 400 kg

Complies With: IEC 60297-3-100

ADDITIONAL PRODUCT DETAILS

Aluminum frame cabinets with attractive design, ideally suited for general electronics, test and measurement, audio/video and broadcasting applications.

CERTIFICATIONS



North America

All locations

+1.763.422.2661

Chat with us:

schroff.nvent.com

Europe

Straubenhardt, Germany

+49.7082.794.0

Betschdorf, France

+33.3.88.90.64.90

Warsaw, Poland

+48.22.209.98.35

Assago, Italy

+39.02.932.7141

Chat with us:

schroff.nvent.com

Asia

Shanghai, China

+86.21.2412.6943

Qingdao, China

+86.532.8771.6101

Singapore

+65.6768.5800

Shin-Yokohama, Japan

+81.45.476.0271

Chat with us:

schroff.nvent.com

Middle East & India

Dubai, United Arab Emirates

+971.4.378.1700

Bangalore, India

+91.80.6715.2001

Istanbul, Turkey

+90.216.250.7374

Chat with us:

schroff.nvent.com



Our powerful portfolio of brands:
nVent.com **CADDY ERICO HOFFMAN RAYCHEM SCHROFF TRACER**

© 2023 nVent. All nVent marks and logos are owned or licensed by nVent Services GmbH or its affiliates. All other trademarks are the property of their respective owners.

nVent reserves the right to change specifications without notice.