

15230-024 NOVASTAR CABINET WITH GLAZED DOOR AND REAR PANEL,
HEAVY-DUTY, RAL 7021, 1967H 553W 600D

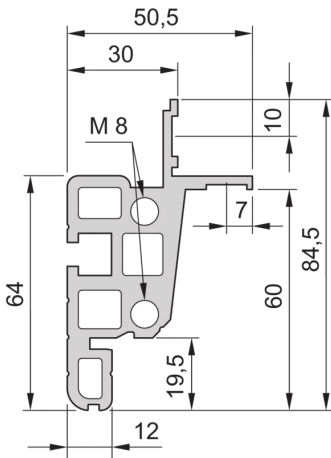
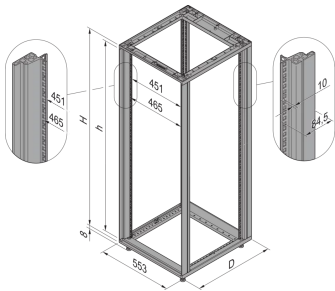
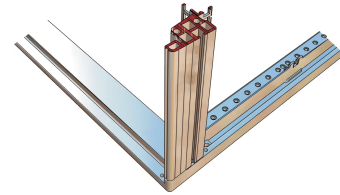
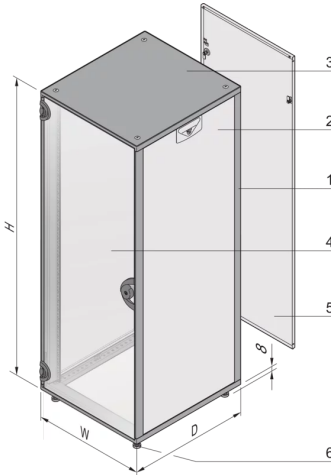

KEY FEATURES

Type of protection IP 20

Cabinet width only 553 mm

Flush cladding parts

All uprights (front and rear) with 19" cut-outs

Bolted, die-cast frame with Al extrusions

With glass door (smoke grey) and rear panel

PRODUCT ATTRIBUTES

Product Type: Cabinet

Product Family: Novastar

Frame Material: Aluminum

Frame Color: Black Grey

Frame Color Code: RAL 7021

Cladding Material: Steel

Cladding Color: Black Grey

Cladding Color Code: RAL 7021

Rack Height: 43 U

Height: 1967 mm

Width: 553 mm

Depth: 600 mm

Static Load: 400 kg

Protection Rating: IP20

Complies With: IEC 60529; IEC 60297-3-100

ADDITIONAL PRODUCT DETAILS

Aluminum frame cabinets with attractive design, ideally suited for general electronics, test and measurement, audio/video and broadcasting applications.

CERTIFICATIONS



North America

All locations

+1.763.422.2661

Chat with us:

schroff.nvent.com

Europe

Straubenhardt, Germany

+49.7082.794.0

Betschdorf, France

+33.3.88.90.64.90

Warsaw, Poland

+48.22.209.98.35

Assago, Italy

+39.02.932.7141

Chat with us:

schroff.nvent.com

Asia

Shanghai, China

+86.21.2412.6943

Qingdao, China

+86.532.8771.6101

Singapore

+65.6768.5800

Shin-Yokohama, Japan

+81.45.476.0271

Chat with us:

schroff.nvent.com

Middle East & India

Dubai, United Arab Emirates

+971.4.378.1700

Bangalore, India

+91.80.6715.2001

Istanbul, Turkey

+90.216.250.7374

Chat with us:

schroff.nvent.com



Our powerful portfolio of brands:
nVent.com **CADDY ERICO HOFFMAN RAYCHEM SCHROFF TRACER**

© 2023 nVent. All nVent marks and logos are owned or licensed by nVent Services GmbH or its affiliates. All other trademarks are the property of their respective owners.

nVent reserves the right to change specifications without notice.