

14575-125 COMPACPRO DESKTOP CASE, UNSHIELDED, 3 U, 42 HP, 331 MM

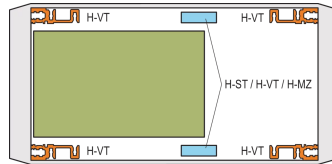
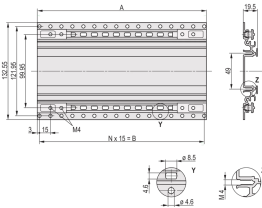
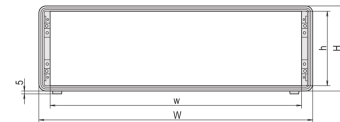
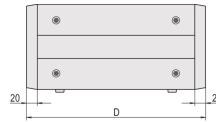
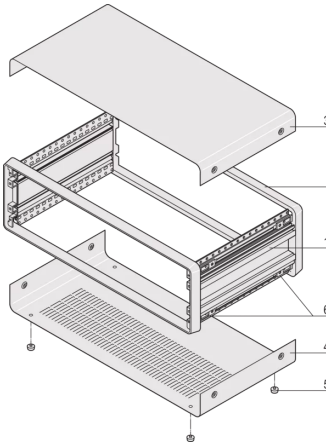

**KEY FEATURES**

- Desktop case for individual assembly
- Aluminum construction ensures robust solution
- International dimensions in accordance with IEC 6297-3-101
- Side panel with integrated handle function
- Front and rear identical, depth-symmetrical construction
- Ventilation slots in base plate
- IP 20 in accordance with IEC 60529

**PRODUCT ATTRIBUTES**

- Product Type: Case
- Product Family: CompacPRO
- Type: Case for Individual Electronic Components
- Rack Height: 3 U

Height: 147.1 mm

Usable Height: 129.3 mm

Rack Width: 42 HP

Width: 257 mm

Usable Width: 219 mm

Depth: 331 mm

EMC Shielding: No

Static Load: 30 kg

Protection Rating: IP20

Front Frame Construction: Single Piece

Cooling Option: No

Complies With: IEC 60297-3-103

Package Quantity: 1

## ADDITIONAL PRODUCT DETAILS

---

The nVent SCHROFF CompacPRO case provides electronics protection for 19" and individual electronic assemblies. The aluminum die cast frame and profile sidepanels guarantee a robust solution. In addition an extensive accessory range is available.

GND / earthing connections in accordance with

## CERTIFICATIONS

---



### North America

All locations

+1.763.422.2661

Chat with us:

[schroff.nvent.com](https://schroff.nvent.com)

### Europe

Straubenhardt, Germany

+49.7082.794.0

Betschdorf, France

+33.3.88.90.64.90

Warsaw, Poland

+48.22.209.98.35

Assago, Italy

+39.02.932.7141

Chat with us:

[schroff.nvent.com](https://schroff.nvent.com)

### Asia

Shanghai, China

+86.21.2412.6943

Qingdao, China

+86.532.8771.6101

Singapore

+65.6768.5800

Shin-Yokohama, Japan

+81.45.476.0271

Chat with us:

[schroff.nvent.com](https://schroff.nvent.com)

### Middle East & India

Dubai, United Arab Emirates

+971.4.378.1700

Bangalore, India

+91.80.6715.2001

Istanbul, Turkey

+90.216.250.7374

Chat with us:

[schroff.nvent.com](https://schroff.nvent.com)



Our powerful portfolio of brands:  
[nVent.com](https://nVent.com) **CADDY ERICO HOFFMAN RAYCHEM SCHROFF TRACER**

© 2023 nVent. All nVent marks and logos are owned or licensed by nVent Services GmbH or its affiliates. All other trademarks are the property of their respective owners.

nVent reserves the right to change specifications without notice.