

10225-615 COMPTEC 19" DESKTOP CASE, UNSHIELDED, STEEL COVER, 6 U, 84 HP, 400 MM

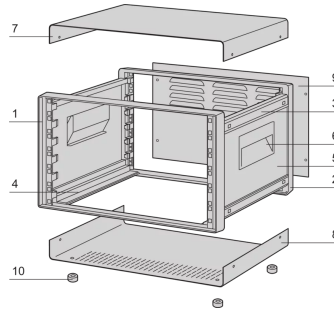
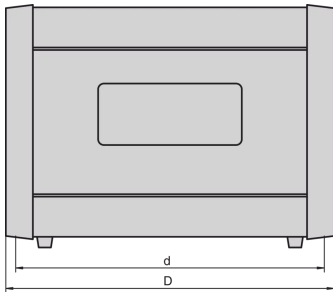
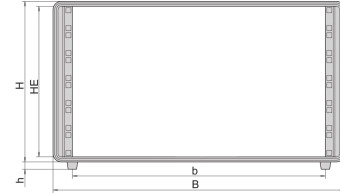
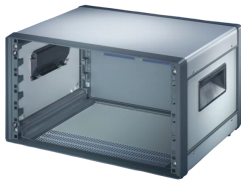

KEY FEATURES

Desktop case (pre-fitted)

Unshielded

Ventilation slits in base plate

Front and rear frames in die-cast Al

Top cover, base plate and rear panel in steel

Conforms with DIN EN 62368-1

PRODUCT ATTRIBUTES

Product Type: Case

Product Family: Comptec

Type: Case for 19" Subrack and 19" Chassis

Rack Height: 6 U

Height: 286 mm

Usable Height: 267.6 mm

Rack Width: 84 HP

Width: 520 mm

Usable Width: 451 mm

Depth: 400 mm

EMC Shielding: No

Static Load: 40 kg

Protection Rating: IP20

Front Frame Construction: Single Piece

Cooling Option: No

Complies With: IEC 60297-3-100

Package Quantity: 1

ADDITIONAL PRODUCT DETAILS

The nVent SCHROFF Comptec case is compatible with a 19" cabinet and is used to house assemblies such as 19" subracks, 19" fan trays or 19" front panels. This case is also typically used for desktop applications.

CERTIFICATIONS



North America

All locations

+1.763.422.2661

Chat with us:

schroff.nvent.com

Europe

Straubenhardt, Germany

+49.7082.794.0

Betschdorf, France

+33.3.88.90.64.90

Warsaw, Poland

+48.22.209.98.35

Assago, Italy

+39.02.932.7141

Chat with us:

schroff.nvent.com

Asia

Shanghai, China

+86.21.2412.6943

Qingdao, China

+86.532.8771.6101

Singapore

+65.6768.5800

Shin-Yokohama, Japan

+81.45.476.0271

Chat with us:

schroff.nvent.com

Middle East & India

Dubai, United Arab Emirates

+971.4.378.1700

Bangalore, India

+91.80.6715.2001

Istanbul, Turkey

+90.216.250.7374

Chat with us:

schroff.nvent.com



Our powerful portfolio of brands:
nVent.com **CADDY ERICO HOFFMAN RAYCHEM SCHROFF TRACER**

© 2023 nVent. All nVent marks and logos are owned or licensed by nVent Services GmbH or its affiliates. All other trademarks are the property of their respective owners.

nVent reserves the right to change specifications without notice.